

Wireless Power Transmission

This chapter presents the history of Wireless Power Transmission (WPT) from Tesla to the rectenna. The basic rectifier, its building blocks and the full-wave modified Greinacher rectifier are then described [4]. The antenna and its issues for WPT illustrate the basic trade-offs that occur. Finally, a numerical example of WPT concludes this chapter.

2.1 History of Wireless Power Transmission

THE idea of Wireless Power Transmission (WPT) was first conceived and explored in 1899 by Nikola Tesla. During a conference, he announced that his personal dream of WPT was realized. He attempted to distribute ten thousand horse-power under a voltage of one hundred million volts. As said in his words: “This energy will be collected all over the globe preferably in small amounts, ranging from a fraction of one horse-power to a few horse-power. One of its chief uses will be the illumination of isolated homes.”

Tesla conducted his experiments in Colorado Springs, Colorado, in 1899 (Fig. 2.1). Under a \$30,000 (value in 1900!) grant from Colonel John Jacob Astor, owner of the Waldorf-Astoria Hotel in New York City, Tesla built a gigantic coil in a large square building over which rose a 60 m mast with a 1 m diameter copper ball positioned at the top. The coil was resonated at a frequency of 150 kHz and was fed with 300 kW of low-frequency power obtained from the Colorado Springs Electric Company. When the RF output was fed to the mast, an RF potential was produced on the sphere that approached 100,000,000 V, according to Tesla [6]. Some of his experiments were related by the journalists of his time. According to them, he succeeded in lighting two hundred 50 W incandescent lamps 42 km away from the base station.

Tesla not only thought that the globe was a good conductor but that the moderate altitude atmospheric layers were excellent conductors. Therefore, he wanted to prove it was possible to use these layers in order to transmit large amounts of electrical

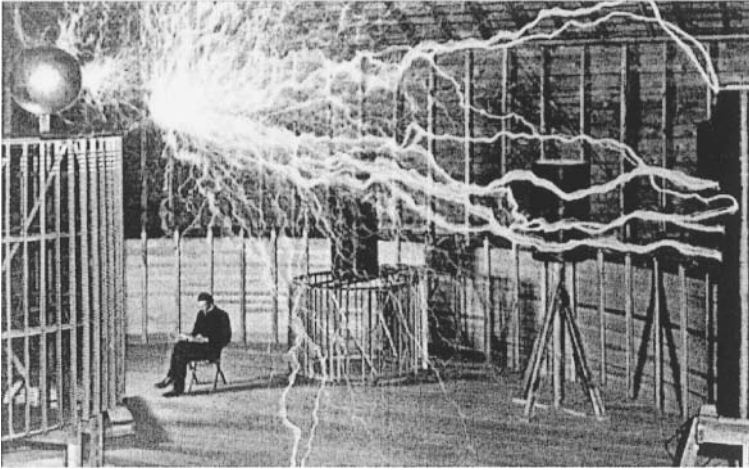

Fig. 2.1. Tesla in his Colorado Spring laboratory

energy over any distance. He proposed the idea (Fig. 2.2) but his sponsor, Morgan, retorted, “If everyone is able to draw energy from there, where would the electricity meter be?”

The work of Tesla was based on very long wavelengths and thus, the concept of radio wave focusing couldn’t be used. The work of Heinrich Hertz demonstrated electromagnetic wave propagation in free space and its possible detection. Although theoretically possible, electromagnetic wave focusing was not feasible in practice, due to the lack of short wavelength generators. The klystron tube and the microwave cavity magnetron arrived in the late 30’s [7]. Real interest in WPT began in the 50’s and triggered the modern history of free-space power transmission. For an extensive historical presentation, the interested reader is referred to [6].

Since Tesla’s experiments on WPT, there has been more than one century of research, with most progress made after 1958, on the topic of high-power beaming. Applications concerning high power transmission, like solar-powered satellite-to-ground systems (SPS) [6] and helicopter powering, have been developed. Typical efficiency of those systems is about 85% at lower microwave frequencies and less than this higher in the spectrum. The common point of these system is the *rectenna*.

2.2 The rectenna

In the work of Tesla, there was a need for an energy transducer. It was needed to convert one type of energy to another. For the WPT in this present work, the energy conversion from RF to DC is realized based on a *rectenna* circuit.

A rectenna is a rectifying antenna, a special type of antenna that is used to directly convert microwave energy into DC electricity. By connecting a Schottky diode to the access of a dipole antenna, we obtain a simple rectenna. The use of a Schottky diode is

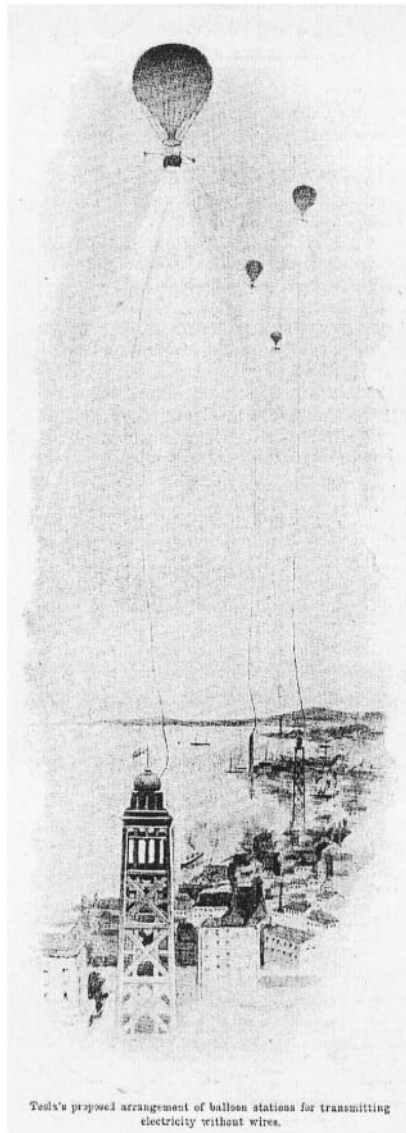

Fig. 2.2. Tesla's idea to transmit electrical energy from the atmosphere down to the earth. The use of a fire balloon would allow the electricity to flow along a conducting wire down to a base station. The city could then be "easily" energized.

necessary to achieve a high efficiency in the overall conversion process. A schematic of a typical rectenna circuit is shown in Fig. 2.3. The antenna captures the power from its surroundings (represented by the power density S) and generates a voltage

at the diode D access. The latter rectifies the voltage to a DC current that charges the capacitor C at the rate RC .

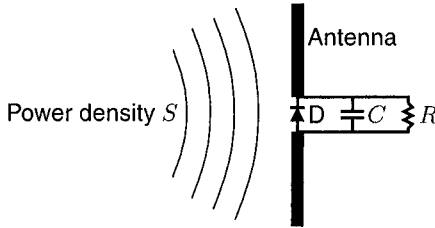

Fig. 2.3. A typical rectenna schematic.

William C. Brown was the first to succeed in demonstrating a microwave powered helicopter in 1964 using the rectenna [6]. The rectenna was thoroughly studied starting from the second half of the twentieth century resulting in high overall efficiency systems. With the advent of integrated circuits and low power technologies, new applications were made possible. In the mid 1980's [8], Radio Frequency IDentification Systems (RFID) appeared in which an inductive or electromagnetic coupling antenna was used for both power transmission and as a communication link. Other applications of WPT include biomedical implants with passive telemetry as a communication link [9]. More recently, the recycling issue of the ambient microwave energy was addressed [10]. The vast majority of these applications make use of a *rectifier* building block, similar to the basic rectenna of Fig. 2.3, to draw their energy.

2.3 Rectifier building blocks

The use of low threshold diodes (e.g. Schottky) and good quality capacitors allow a continuous voltage to be drawn out of a small amplitude pulsed signal (typically sinusoidal). The rectifier circuit is built out of two basic electrical circuits, the *clamping circuit* and the *envelope detector circuit*.

2.3.1 Clamping circuit

The goal of this circuit is to establish a DC reference for the output voltage by using a diode clamp as shown in Fig. 2.4.

By conducting whenever the voltage at the output terminal of the capacitor v_{out} goes negative, this circuit builds up an average charge on the terminal that is sufficient to prevent the output from ever going negative. Positive charge on this terminal is effectively trapped. If all elements are ideal, the residual negative voltage Δv_r is null and v_{out} is exactly equal to $\widehat{v}_{in} + v_{in}$ where \widehat{v}_{in} is the peak amplitude of v_{in} .

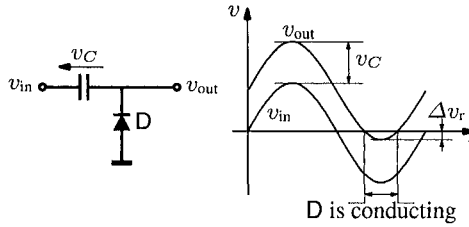

Fig. 2.4. Diode clamp circuit and its output waveform.

2.3.2 Rectifier circuit

When a voltage v_{in} is applied on the input of the circuit of Fig. 2.5, the capacitor charges until its voltage v_C is equal to the maximum of v_{in} . If no resistor is connected

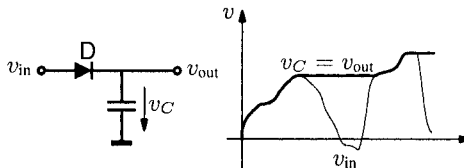

Fig. 2.5. Basic rectifier circuit and its output waveform.

in parallel with the output capacitor, the voltage v_{out} never reduces.

In practice, the leakage current of the capacitor induces an output voltage drop. If v_{in} is a sinusoidal signal, the capacitor will charge every time its voltage is near its peak value. Consequently, the mean output voltage $\overline{v_{out}}$ is slightly smaller than the peak amplitude of v_{in} .

In both cases, the threshold voltages of the diodes are not taken into account. But it should be mentioned that they further reduce the output voltage amplitude. All these effects are addressed later in this chapter.

2.3.3 The voltage doubler

The voltage doubler is obtained by cascading the blocks from sections 2.3.1 and 2.3.2. The result is shown in Fig. 2.6

As can be seen in Fig. 2.6, and from 2.3.1 and 2.3.2, the voltage doubler outputs a DC voltage. In the ideal case, v_{out} is twice the amplitude of v_{in} . This circuit is actually a half wave voltage doubler since only the positive peaks of the input signal are rectified. To take advantage of both positive and negative peaks, one must use the full-wave rectifier.

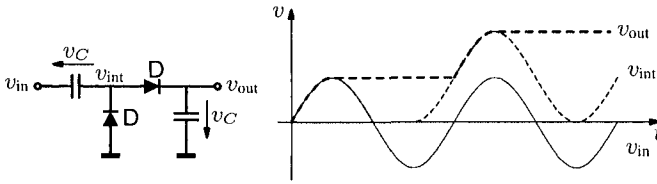

Fig. 2.6. Voltage doubler circuit and its waveforms.

2.3.4 Full-wave rectifier

In this case, the structure of Fig. 2.6 is mirrored with respect to the ground. The *full-wave rectifier* is obtained and is represented in Fig. 2.7. The waveforms shown are

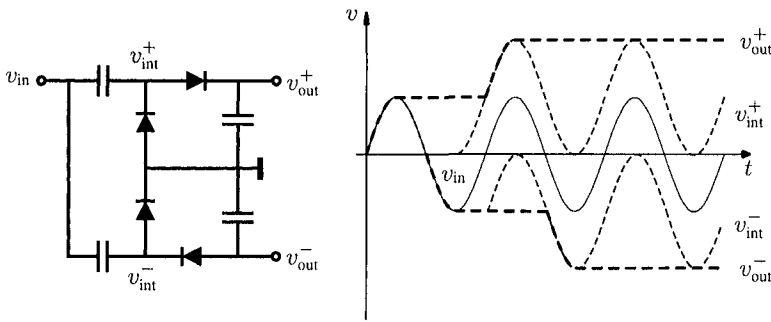

Fig. 2.7. Full-wave voltage doubler circuit and its waveforms.

only valid in the ideal case, i.e. zero leakage capacitors, no threshold voltage (0 V) and no reverse current in the diodes.

In practice, in low power applications, the voltage level at the input of a rectifier as in Fig. 2.7 is on the order of a few hundred millivolts. The non-idealities of real-life components noticeably affect the voltage multiplication factor between the output voltage and the input amplitude. The minimum supply voltage for today’s RFID tags is typically 1.2 V. To achieve such an amplitude level, one has to cascade the circuit of Fig. 2.7. It results in the Greinacher cascade of Fig. 2.8(a).

2.3.5 Full-wave Greinacher rectifier

A little modification in the rectifier of Fig. 2.8(a) leads to the circuit of Fig. 2.8(b). The rectifier is first symmetrized and then the capacitors are rearranged so that every rectifying diode is excited with the same input signal amplitude. The resulting topology offers a nice symmetry. To reduce the number of capacitors, one could disconnect C_1 and C_2 from the ground and combine them to form only one “output or charging capacitor” per stage.

More importantly, its low power input impedance is smaller than in the non-modified version. This can be an advantage when the antenna-transponder matching issue is addressed. Another advantage of this structure is the lower capacitive losses along the RF path to the diodes. The capacitors act indeed as voltage dividers. Thanks to its symmetry, the modified structure reduces the reflected harmonic content.

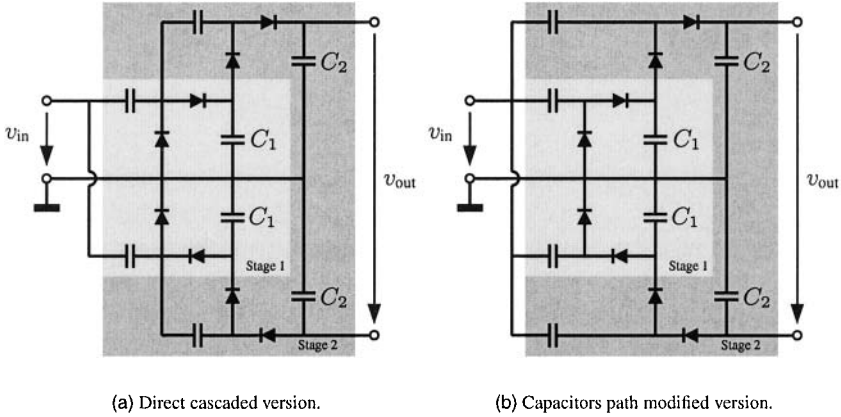

Fig. 2.8. Full-wave modified Greinacher rectifiers.

The output voltage is equal to $4N\widehat{v}_{in}$ where N is the number of stages. But in both cases, the dynamic impedance issue, due to the output current consumption and the input voltage impedance (e.g. the antenna), deeply affects this simple result. As will be shown in the next chapter, the use of rectifiers at low power levels is a challenging task when both the power and operating range issues are taken into account.

2.4 Antenna

The antenna is the second building block of the rectenna (see Fig. 2.3). Its characteristics affect in many ways the overall efficiency of WPT systems. In general, an arbitrary antenna has a complex input impedance (related to the feeding point) which can be written in the form $Z_{ant} = R_A + jX_{ant}$, where $R_A = R_{loss} + R_s$ (see Fig. 2.9).

R_s is the radiation resistance of the antenna, R_{loss} is the loss resistance of the antenna, X_{ant} is the imaginary part of the antenna input impedance, S corresponds to the effective aperture of the antenna and P_{AV} is the available power that the antenna can deliver to a *matched* load.

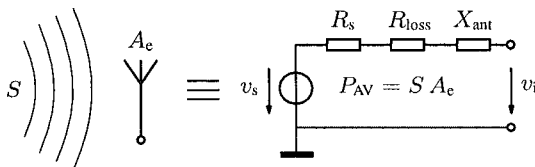

Fig. 2.9. Antenna equivalent electrical model.

2.4.1 Loss resistance

The loss resistance R_{loss} is due to the actual resistance of the elements that form the antenna (typically the copper in a patch antenna and the chosen dielectric), and to dielectric losses. Power dissipated in this manner is lost as heat. Although it may appear that the "DC" resistance is low, at higher frequencies the *skin-effect* δ is in evidence and only the surface areas of the conductor are used (see Fig. 2.10). As a result the effective resistance is higher than would be measured at DC for closed loop antennas (see Fig. 2.11). It is proportional to the circumference of the conductor and to the square root of the frequency (see Eq. (2.1)).

The resistance can become particularly significant in high current sections of an antenna where the effective resistance is low. Accordingly, to reduce the effect of the loss resistance it is necessary to ensure the use of very low resistance conductors.

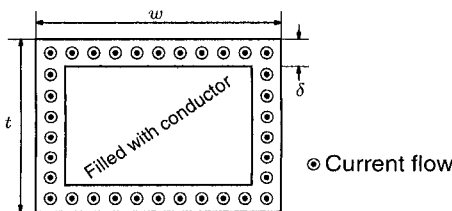

Fig. 2.10. Cross-section of a conductor. It shows the current near its surface.

The losses due to the skin-effect can be modeled by a resistance known as the high frequency resistance R_{HF} and its value can be calculated with the following approximation

$$R_{HF} \approx \frac{1}{\sigma \delta (\text{conductor perimeter})} = \sqrt{\frac{\mu_0 \pi f}{\sigma}} \frac{1}{(2w + 2t)} \tag{2.1}$$

where w and t are the width and the thickness of the conductor (see Fig. 2.10), σ is the material conductivity and μ_0 is the permeability of free space.

The losses are difficult to evaluate but, at UHF, R_{loss} is generally negligible compared with R_s . *In this work, the effect of R_{loss} is neglected.*

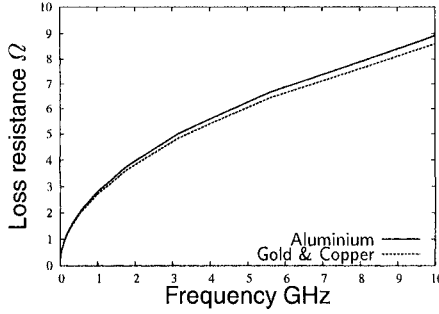

Fig. 2.11. High frequency resistance in different materials. These results are valid for a conductor whose cross-section size is 1 mm width \times 35 μ m thickness.

2.4.2 Radiation resistance

The other resistive element is the "radiation resistance." This can be thought of as virtual resistor. It arises from the fact that power is "dissipated" when it is radiated. The aim, when designing an antenna, is to "dissipate" as much power in this way as possible. It varies from one type of antenna to another, and from one design to another. It is dependent upon a variety of factors. A typical half wave folded dipole operating in free space has a radiation resistance of around 300 Ω (see Table 4.5).

Note that the radiation resistance is not a real resistor, but simply a convenient form for representing a loss of energy from the antenna. In a real resistance, the lost energy is converted to heat. With respect to radiation resistance, *the energy isn't converted to heat, but simply radiated as radio waves.*

2.4.3 Antenna-Rectifier interface

The antenna is connected to the rectifier, which contains diodes that are sensitive to the voltage at their ports. In order for the diodes to transmit power (by reducing the real part of their impedance) the voltage level has to be sufficient. Moreover, it is necessary that the voltage applied to the diodes be greater than (or approaching) their threshold voltage. As will be described in the next chapter, the physical condition for the rectifier to deliver a growing output voltage is satisfied when the charge due to the direct current exactly compensates the charge due to the inverse current of a rectifying diode. The voltage source amplitude \hat{v}_s (see Fig. 2.9) is equal to

$$\hat{v}_s = 2\sqrt{2R_s P_{AV}}. \quad (2.2)$$

\hat{v}_s is thus proportional to the square-root of the radiation resistance R_s . If the rectifier is modeled (zero order approximation) as a resistive load R_i (see Fig. 2.12), the input voltage v_{in} is equal to

$$\hat{v}_{in} = \hat{v}_s \frac{R_i}{R_i + R_s} = 2\sqrt{2R_s P_{AV}} \frac{R_i}{R_i + R_s} \quad (2.3)$$

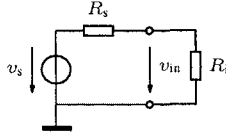

Fig. 2.12. First order model of the antenna connected to the rectifier.

Equation (2.2) shows that to increase \widehat{v}_s , a high radiation resistance R_s is mandatory. Furthermore, from (2.3), it is clear that the maximal transmitted power is obtained as antenna-rectifier matching is ensured, i.e. when the connected load impedance R_i is exactly equal to R_s (or $Z_{in} = Z_{ant}^*$ in the complex case). This result is very important to WPT because it says in essence that to design an optimal WPT system, it is necessary to have both *power-matching* and a *high radiation resistance at the receiving end of the system*.

2.4.4 Numerical example

To gain more insight into the WPT issues, a numerical example is presented in this section.

A typical WPT system is shown in Fig. 2.13. The effective isotropically radiated power P_{EIRP} , equal to $P_{RF} G_{PA} G_t$, is radiated in the direction of a battery-less device situated at a distance d . The power density S at the device antenna is

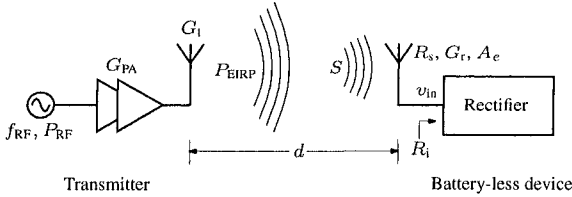

Fig. 2.13. Typical WPT system.

$$S = P_{EIRP} \frac{1}{4\pi d^2}.$$

The power P_r collected by the device antenna and transferred to the load is

$$P_r = A_e S$$

where A_e is the effective aperture of the antenna. In general, the maximal effective aperture is related to the antenna gain G_r and the wavelength λ_{RF} by

$$A_e = \frac{\lambda_{RF}^2}{4\pi} G_r \tag{2.4}$$

so that P_r is

$$P_r = S \frac{\lambda_{\text{RF}}^2}{4\pi} G_r = P_{\text{EIRP}} G_r \frac{\lambda_{\text{RF}}^2}{(4\pi d)^2} \quad (2.5)$$

Eq. (2.5) is known as the *Friis relation*.

Using (2.3), the input voltage \widehat{v}_{in} at the rectifier is

$$\widehat{v}_{\text{in}} = 2\sqrt{2R_s P_{\text{AV}}} \frac{R_i}{R_i + R_s} \quad (2.6)$$

$$= 2\sqrt{2R_s} \frac{R_i}{R_i + R_s} \sqrt{P_{\text{EIRP}}} \frac{\lambda_{\text{RF}}}{4\pi d} \sqrt{G_r}. \quad (2.7)$$

Substituting the typical values of Table 2.1, \widehat{v}_{in} is plotted for different values of R_s and R_i as a function of the distance d in Fig. 2.8.

Table 2.1. Typical values borrowed from the FCC regulations for a WPT system operating at 2.45 GHz.

λ_{RF}	12.24 cm
P_{EIRP}	4 W

Fig. 2.14 clearly shows that the main challenge for WPT applications is the ability to deal with less than a 100 mV input signal amplitude. Reaching distances of more than 10 m is particularly demanding since \widehat{v}_{in} is inversely proportional to the distance. The impedance arrangement also has a noticeable impact. In Fig. 2.14(a), there are no differences between the 300 Ω and the 900 Ω but from the four figures, it is clear that a high input resistance performs better. In Fig. 2.15, the input voltage \widehat{v}_{in} available at a distance of 10 m is represented for different values of R_i as a function of R_s . In order to maximize \widehat{v}_{in} , it is necessary to have a high value for R_i . At high frequencies, such values are difficult to obtain because of parasitics; a 1 pF capacitance operating at 2.45 GHz represents $-j65 \Omega$, limiting the real impedance level. Careful design and technology choices allow the overall input capacitance level presented to the antenna to be kept to a minimum. But values below 500 fF are not easily realized. As will be shown in chapter 3, R_i depends on the output current consumption. Consequently, the consumption of the WPT device has to be minimized.

2.4.5 WPT today and possible future applications

Considering today's typical regulations, the monolithic modified Greinacher rectifier is a viable candidate for short range micro-powered devices. RFIDs make extensive use of rectifiers as power supplies both in the low frequency range and in the UHF range. Working range of about 15 m is announced by industrials [11] for an emitted power of 30 W at 915 MHz (US licensed site). Wireless distributed sensor networks could also benefit from such a technology, e.g. for automatic tire temperature or pressure control [12]. Micro-batteries, e.g. thin film lithium ion cells, could store

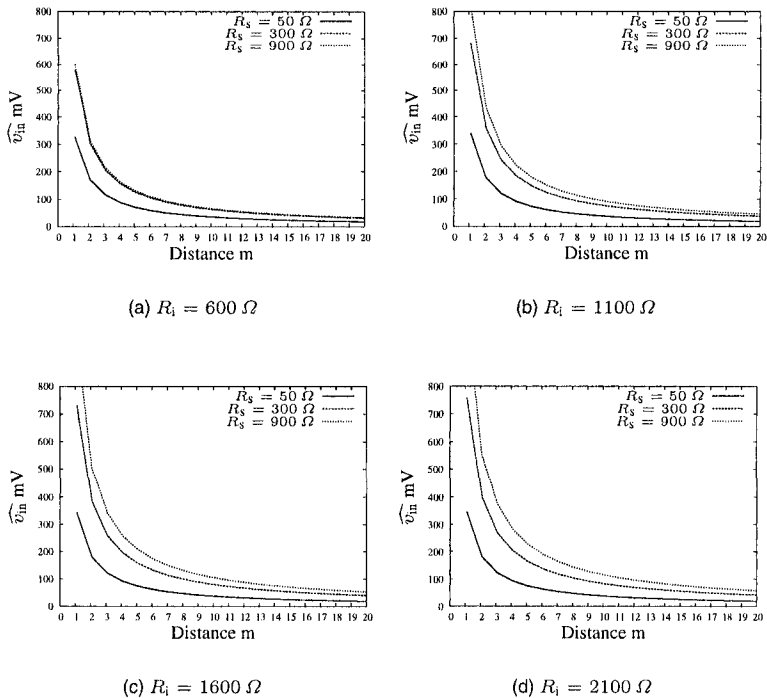

Fig. 2.14. Input voltage \widehat{v}_{in} for different value of R_s and R_i as a function of the distance d .

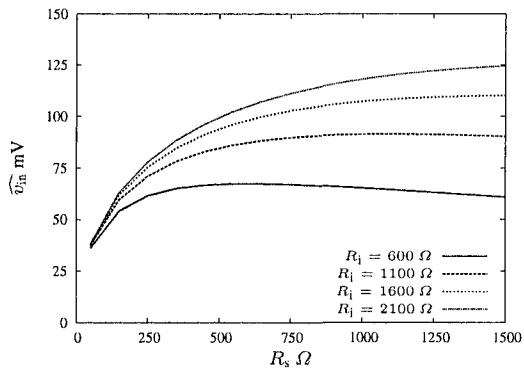

Fig. 2.15. Available voltage at 10 m of a 4 W transmitter in different impedance level conditions.

energy during idle time, or a dedicated frequency band could be used (as proposed by the ITU [13]) to supply the necessary power to a sensor when demanded. The data obtained could then be captured using typical RFID communication techniques, e.g. backscattering (see chapter 4).

2.5 Conclusion

The issues for wireless power transmission have been described. The possible circuit topologies that allow RF signal rectification have been presented. The modified-Greiner structure constitutes a viable candidate for WPT devices. The antenna has also been identified to be a fundamental component of any WPT system. Finally, a numerical example gave some insight into the numbers involved. This concludes this chapter and opens the development of the modified-Greiner structure model derived in the next chapter.